

KIT ORING MOTOCICLETAS

55 REFERENCIAS X 1820 UND



**GRATIS
ORGANIZADOR**

ALTURA: 23 CMT
ANCHO: 32.5 CMT
FONDO: 16.5 CMT

O'RINGS



KIT PULGADAS



KIT MILIMETROS

DISPARCOL LTDA.

KIT VARILLA FRENO



CHAVETAS PARA MOTOS

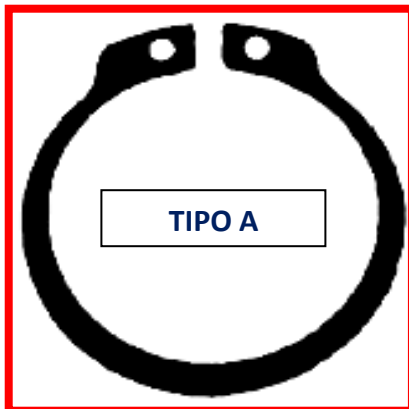

KIT CHAVETAS



DISPARCOL LTDA.

TORNILLERIA

HEXAGONAL ZINCROMATIZADO

5MM – 6MM – 7MM - 8MM



HEXAGONAL TIPO FLANGE (ARANDELADO)

6MM – 8MM – 10MM



HEXAGONAL 6MM LLAVE 8 (ORIGINAL TAPAS MOTOR)



DISPARCOL LTDA.

TORNILLERIA

TORNILLO CABEZA BRISTOL ZINCADO 5MM – 6MM – 8MM



TORNILLO GOLOSO ESTRIA



GOLOSO LENTEJA PAVONADO
4X20 Y 5X20
ORIGINAL PASTAS BWS, CRYPTON, SCOOTER CHINAS



TORNILLO GOLOSO ALUMINIO M5X16



DISPARCOL LTDA.

TORNILLERIA

TORNILLO ESTRIA

CAB.CILINDRICA 3MM-4MM-5MM-6MM



CAB.AVELLANADA 4MM-5MM-6MM



TORNILLO ESTRIA Y BRISTOL CABEZA LENTEJA (CARENAJE)



ESTRIA LENTEJA CROMADO: 5X12-5X15-5X20-5X25-6X15-6X20-6X25

ESTRIA LENTEJA PAVONADO: 5X12

BRISTOL LENTEJA PAVONADO: 6X15-6X20-6X25

DISPARCOL LTDA.

TORNILLERÍA ESPECIAL MOTOS

TORNILLO PORTABANDAS

SUZUKI-UNIVERSAL



HONDA HERO ECO



YAMAHA RX



BOXER/PULSAR



TORNILLO PATA LATERAL

UNIVERSAL



AX100



YAMAHA RX-V80



TORNILLERIA ESPECIAL MOTOS

EMBLEMAS TANQUE AX100/115



TORNILLO SIN FÍN
CLUTH AX100/115



BOMBA FRENO/ACEITE RX100/115



DISPARCOL LTDA.

TORNILLERIA ESPECIAL MOTOS

TORNILLO DE MANIGUETA

AKT125S/SL



DTK/TS 125
RX 100/115



HERO/ECO100



FR80/100



CBF 150
CROMADO



AX100/115



BOXER MN



TORNILLOS AJUSTE BALANCIN-VALVULAS

XL125/185 - AKT125TT



C70/C90/HERO/BOXER



TORNILLO DE
MANIGUETA
PULSAR180II -FZ16



TORNILLO PIÑON GUIA CADENILLA HONDA

ECO-SPLENDOR



TORNILLO PORTAPLACA



TORNILLO TENSOR MANIGUETAS



TORNILLERIA ESPECIAL MOTOS

TORNILLO TENSOR CADENA



TORNILLO LUJO PLACA ESTRELLA Y FIGURADO

AZUL-ROJO-DORADO-NEGRO-NARANJA CARTON X 24 UND

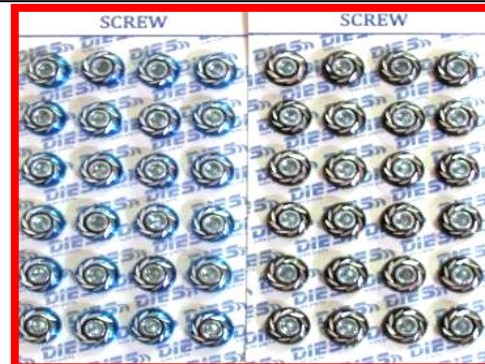

TORNILLO LUJO PLACA LIZO

AZUL-ROJO-DORADO-VERDE-CROMADO-MORADO-BLANCO-NEGRO CARTON X 24 UND



DISPARCOL LTDA.

ESPÁRRAGOS DE CILINDRO Y CULATA

M6X6X30 SALIDA EXHOSTO
DTK100/125, CIL.DE TS



M6X6X35 SALIDA DE XL125



M6X6X45 SALIDA EXHOSTO
KW-TELESCOPICOS XL125



M6X6X100 CILINDRO FZ50-FURIA 80

M6X6X125 CILINDRO FR80/100



M8X8X30 CAMPANAS
AUTECO



M8X8X35 CILINDRO
TS125, ER125, SALIDA TS



M8X8X40 CAMPANA
ECO/SPLENDOR



M8X8X45 CAMPANA ECO-
SPLENDOR,SALIDA RX



M8X8X60 CULATA YAMAHA



M8X3/8X60 CULATAS



M8X7/16X60 CULATAS



M8X1/2X60 CULATAS



M8X6X50 CULATAS



BUJES DE PORTACATALINA

CD100/HERO/ECO100/
SPLENDOR



YAMAHA V-80



PULSAR135/180-DISCOVER



BOXER100/CT



LIBERO 110



GN125 H



AX100/115-AKT100-VIVAX115



AKT 110



RX115-CRIPTON



HONDA C70/C90



AUTECO PLATINO



BUJE EXTERNO PORTACATALINA
PULSAR/DISCOVER



NUEVAS REFERENCIAS

*M12 PASO 1.25

*1/2 ROSCA FINA

TAPONES DE CARTER

M10 1.25 AX100-FR80

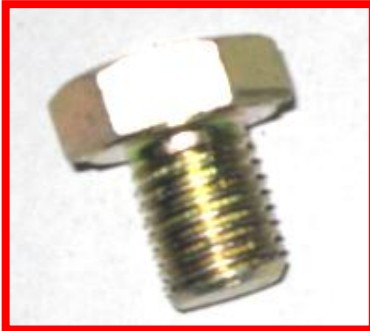

**M12 1.50 TS125-C90-HERO-
ECO-CRIPTON-BOXER-DTK**



**M14 1.50 YAMAHA FZ16
M14 1.25 SUZUKI GN125**



INCLUYEN ARANDELA DE COBRE

KIT DE TIJERA EN TEFLON

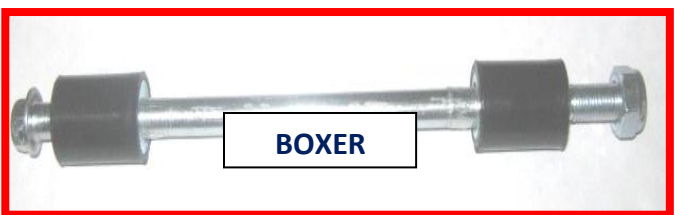
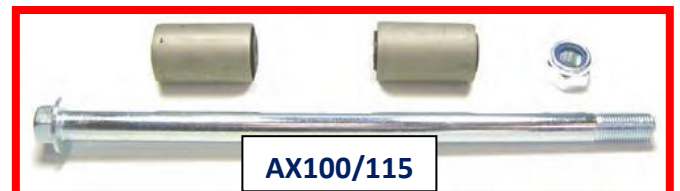

KIT DE TIJERA EN TEFLÓN

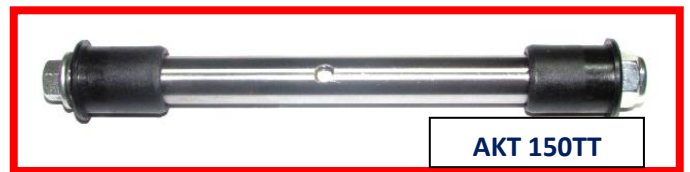
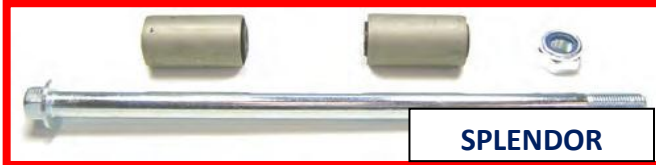
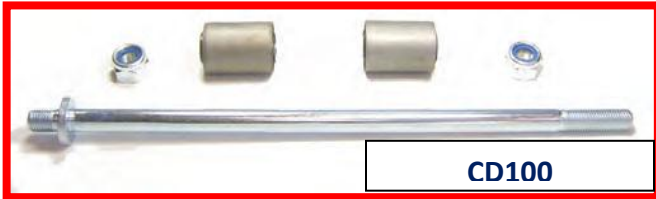

CHAPETAS DE CARENAJE PARA TORNILLO MILIMETRICO



CHAPETAS DE CARENAJE PARA TORNILLO GOLOSO

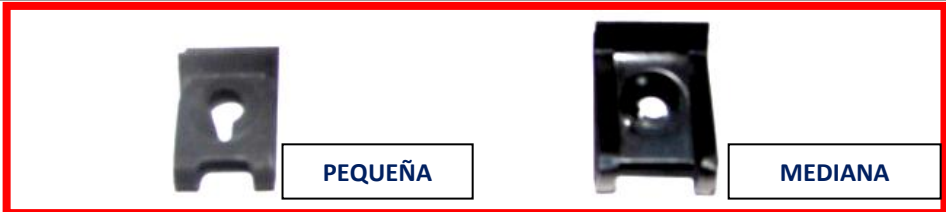

MICOS DE GUAYA EN BRONCE

MICOS DE CLUTH UNIVERSAL



MICOS DE CLUTH CAB.HEXAGONAL



MICOS DE CLUTH ABIERTO



MICOS DE ACELERADOR
CAB.CUADRADA



MICOS DE ACELERADOR
ABIERTO



MICOS DE CLUTH
MOTOCARRO

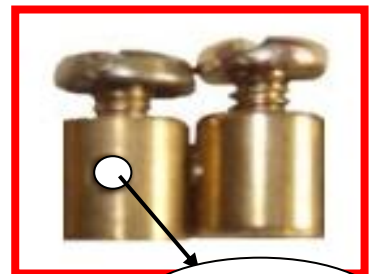

ORIFICIO DE
3MM

TERMINALES ELECTRICOS

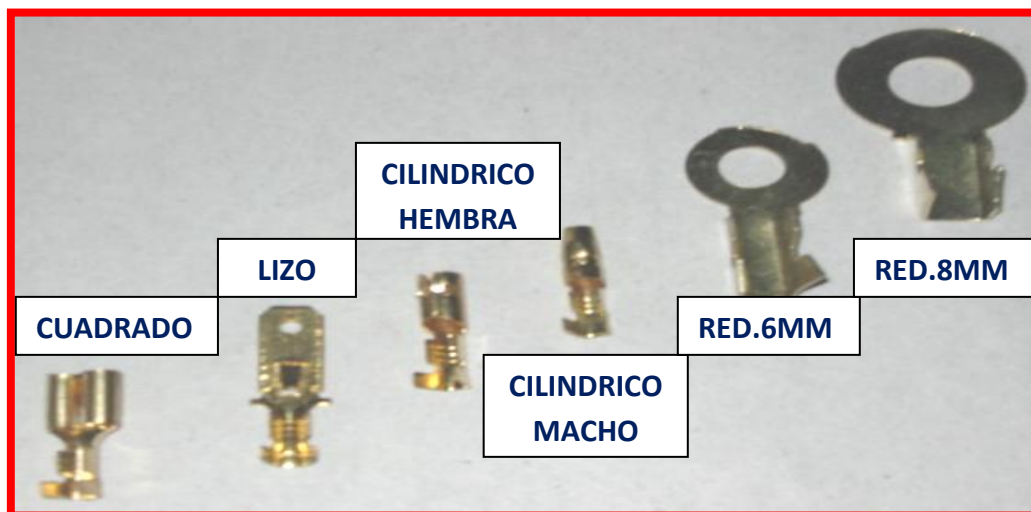

DISPARCOL LTDA.

KIT DE PERNOS Y LAINAS



AX100-115



RX-V80



XL125-AKT125TT



SIGMA100-GN125



BOXER100 CT



ECO-SPLENDOR-CD100



PULSAR DTSI



HONDA C70/C90

ABRAZADERAS DE CREMALLERA

1.1 Abrazadera MINI en acero al CARBÓN protección ZINC (Miniature Clamps) SERIE 10

Descripción:

Abrazadera al carbón de cremallera y ajuste por tornillo sin fin de diversos diámetros.

- Abrazadera compacta de fácil instalación en ubicaciones estrechas.
- Fabricadas con materiales de primera calidad.
- Tornillo sin fin con cabeza hexagonal de 1/4" (6.35 mm).

TORQUE DE INSTALACIÓN

15	lbf • in
1.69	N • m

TORQUE LIBRE

4	lbf • in
0.45	N • m

DIÁMETROS DE APLICACIÓN

Ref. S-10 Acero al carbón protección zinc	D= Rango - Diámetro				
	Milímetros (mm)		Pulgadas (in)		Para mangueras con diámetro
	Min.	Max.	Min.	Max.	
10-00	6	9.5	1/4"	3/8"	1/4"
10-04	8	15.7	5/16"	5/8"	3/8"
10-06	11.2	19.8	7/16"	25/32"	1/2"
10-08	12.7	23.1	1/2"	29/32"	5/8"
10-10	14.2	26.9	9/16"	1 1/16"	3/4"
10-12	17.5	31.7	1 1/16"	1 1/4"	1"
10-16	20.6	38.1	13/16"	1 1/2"	1 1/2"
10-20	20.6	44.4	13/16"	1 3/4"	1 3/4"
10-24	26.9	50.8	1 1/16"	2"	2"
10-28	33.3	57.1	1 5/16"	2 1/4"	2 1/4"
10-32	39.6	63.5	1 9/16"	2 1/2"	2 1/2"
10-36	45.9	69.8	1 13/16"	2 3/4"	2 3/4"
10-40	52.3	76.2	2 1/16"	3"	3"
10-44	58.6	82.5	2 5/16"	3 1/4"	3 1/4"
10-48	65.0	88.9	2 9/16"	3 1/2"	3 1/2"
10-52	71.4	95.2	2 13/16"	3 3/4"	3 3/4"
10-56	77.7	101.6	3 1/16"	4"	4"

NUEVO
SISTEMA
INTERLOCK

ABRAZADERA CINTA
DELGADA 10-24 PARA
FILTRO AIRE/CARBURADOR

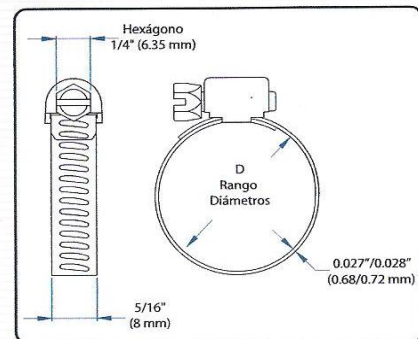

**ABRAZADERA DE CREMALLERA
Y TIPO INDUSTRIAL, ACERO AL
CARBÓN & INOXIDABLE**
Certificado No. 4901/5276
Certificado de Marca SGS No. C01 030
STANDARD: Norma Técnica
SAE J1508:1997
Host Clamp Specification
SGS Colombia Cra. 16A No 78 - 11 piso 3
Tel.: 606 92 92 Bogotá D.C. Colombia

AMARRES PLÁSTICOS

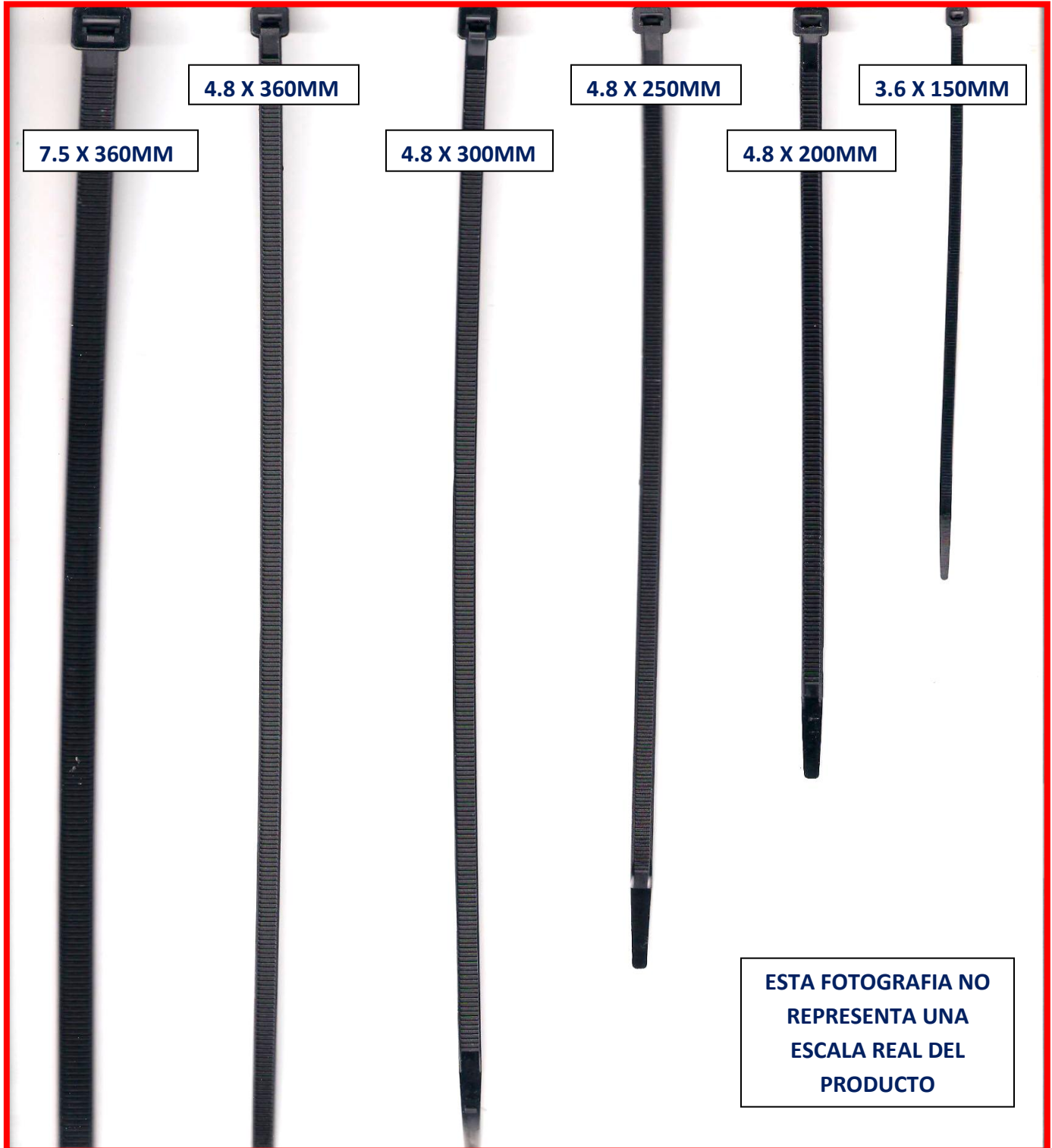

DISPARCOL LTDA.

ABRAZADERAS ESPECIALES



PINES PARA ENCHAVETAR

1/16 - 3/32



LAINAS DE FIJACIÓN

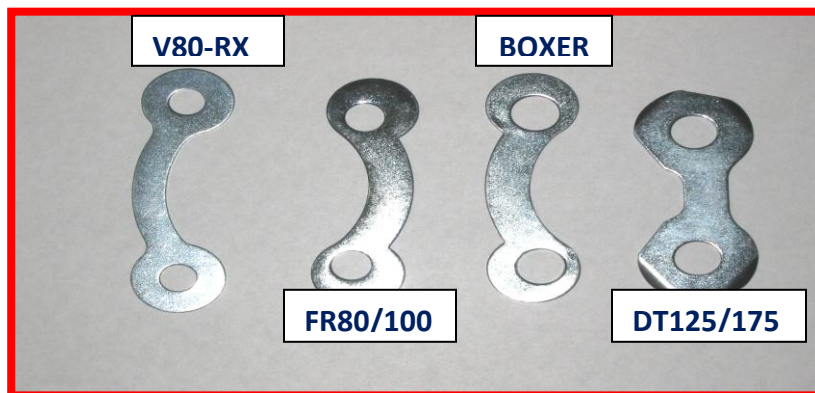

DISPARCOL LTDA.

EJES DE RUEDA DELANTEROS



YAMAHA

REFERENCIAS:
RX100/115
V80
CRYPTON
BWS 100



SUZUKI

REFERENCIAS:
AX 100/115
BEST 125



HONDA

REFERENCIAS:
CD 100



auteco

REFERENCIAS:
BOXER 100
PULSAR 180



AKT
MOTOS
Poder a tu Alcance

REFERENCIAS:
AKT 110 S
AKT 125 S

EJES DE RUEDA TRASEROS



YAMAHA

REFERENCIAS:
RX100/115
V80
CRYPTON
DTK125



SUZUKI

REFERENCIAS:
AX100/115
VIVA/VIVAX 115
TSZ 125



HONDA

REFERENCIAS:
CD 100



auteco

REFERENCIAS:
BOXER 100



CAKT
MOTOS
Poder a tu Alcance

REFERENCIAS:
AKT 110 S
AKT 125 S

VARILLAS FRENO

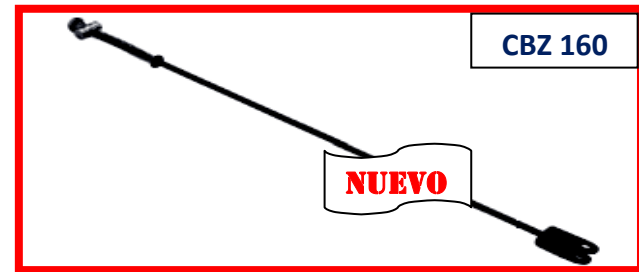
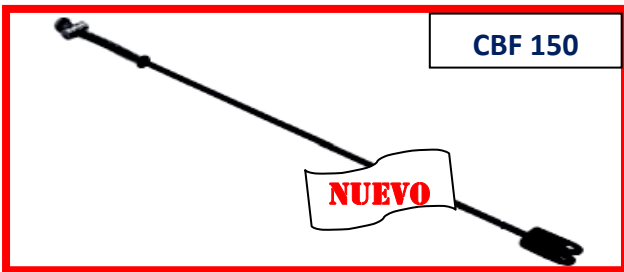
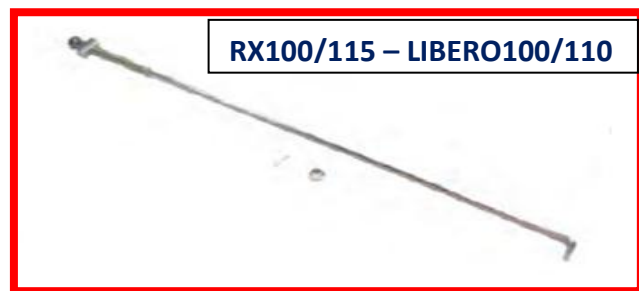
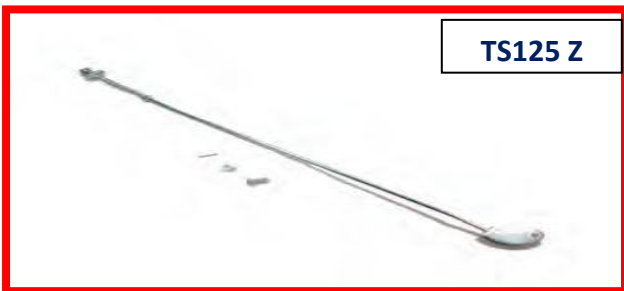
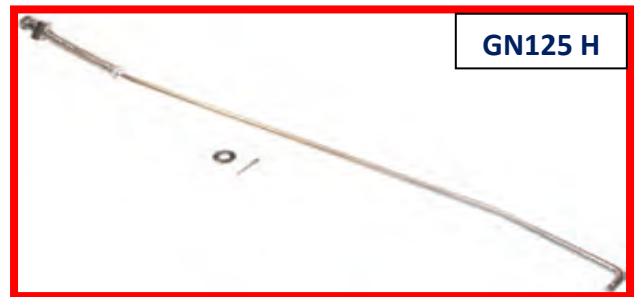
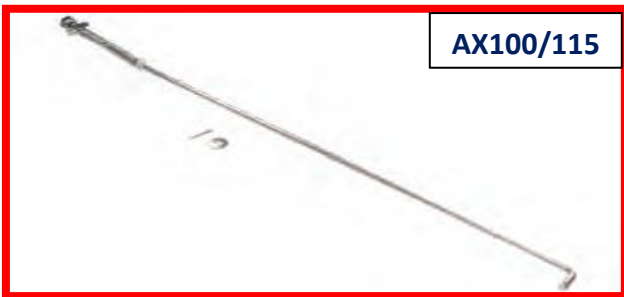
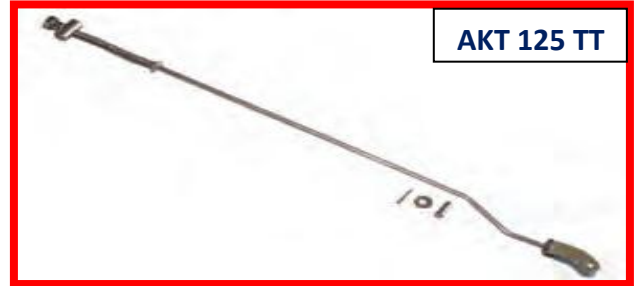
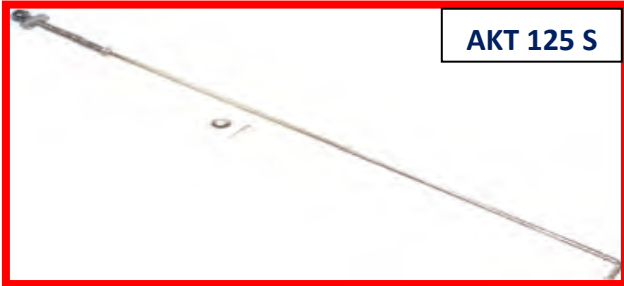

PASADOR VARILLA FRENO UNIV.



VARILLAS DE FRENO



V-80



YBR 125

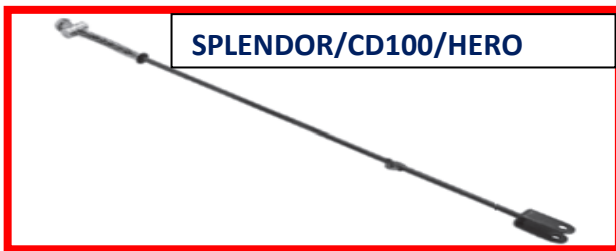

SPLENDOR/CD100/HERO

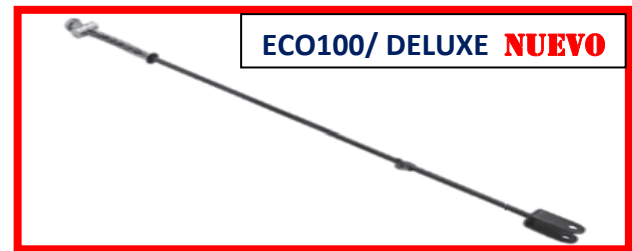

ECO100/ DELUXE **NUEVO**



AKT110 S



PULSAR 180



BOXER



CRIPTON



DTK

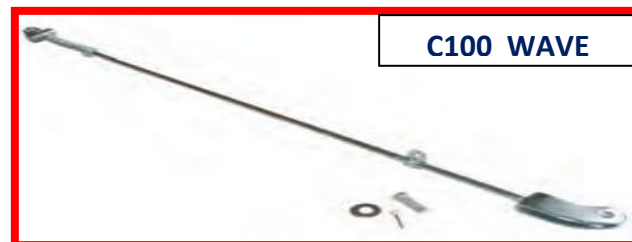

C100 WAVE

TENSORES DE CADENA

DERECHOS E IZQUIERDOS

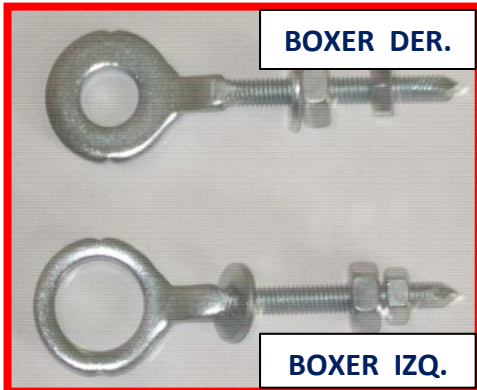

TUERCAS

TUERCA HEXAGONAL ZINCROMATIZADA



10MM LLAVE 14



12MM LLAVE 17



TUERCA TIPO FLANGE (ARANDELADA)



TUERCAS

TUERCAS DE PINAR

10MM EJE DEL.
V-80/C70/AX/FR



12MM EJE TRAS.
V-80/C70/AX



14MM EJE TRAS.
DT/TS125/XL



16MM EJE TRAS.
XLR

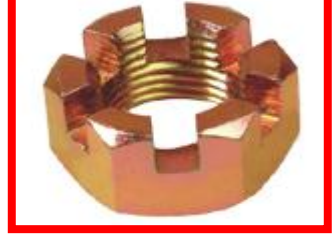

TUERCAS DE SEGURIDAD

5MM-6MM-8MM-10MM-12MM-14MM



TUERCAS CIEGAS CROMADAS

10MM Y 12MM



AMORTIGUADORES

BULONES VARILLA FRENO

6MM (DIAM 11MM)



5MM (DIAM 10MM)

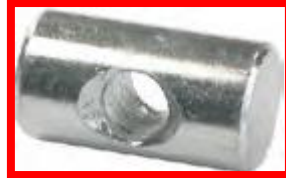

6MM (DIAM 10MM)



TUERCAS ESPECIALES

TUERCAS DE VARILLA FRENO



5MM Y 6MM



6MM

TUERCAS DE BUJE PORTACATALINA



PULSAR/DISCOVER

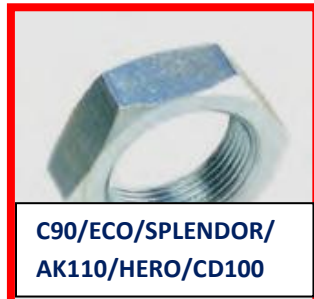

C90/ECO/SPLENDOR/
AK110/HERO/CD100

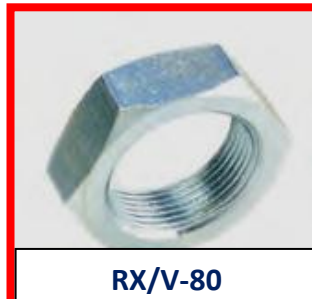

RX/V-80



BOXER100 CT

DISPARCOL LTDA.

TUERCAS ESPECIALES

TUERCAS PIÑÓN DE ARRASTRE/SALIDA

AX/AKT100



TS 125 Z



DTK125/RX



TUERCAS DE PRENSA CLUTH

HONDA C70/C90/ECO/CD100/SPLENDOR



PULSAR



XL125/AKT125TT



ARANDELAS

ARANDELAS DE COBRE MILIMETRICAS

5MM-6MM-8MM-10MM-12MM-14MM



ARANDELAS PLANAS ZINCROMATIZADAS

4MM-5MM-6MM-8MM-10MM-12MM-14MM-16MM



5MM-6MM-8MM CUERPO ANCHO

DISPARCOL LTDA.

ARANDELAS

ARANDELAS DE PRESION (WASAS)



BALINERAS PARA MOTOCICLETAS



CINTAS

NEGRA X 5MT



NEGRA X 15MT



TEFLON X 10MT



DISPARCOL LTDA.

PRODUCTOS UNIFIX



RESISTENTE AL CALOR Y A LA HUMEDAD. SE USA PARA REPARACIONES EN CHASIS, TANQUES DE GASOLINA, RADIADORES, EXHOSTOS Y ARREGLOS CASEROS.

OFERTA DOCENA X 13 UND



UNE EN TAN SOLO 10 MINUTOS CUALQUIER TIPO DE SUPERFICIE REPARANDOLA, PEGANDOLA O SOLDANDOLA CON UNA EFICIENCIA INIGUALABLE. GRACIAS A SU RESISTENCIA AL AGUA, TEMPERATURAS HASTA 110C, LO HACEN IDEAL PARA PEGAR TODO TIPO DE MATERIAL.

OFERTA X 6 UND – GRATIS 1



UNA SOLA GOTA PEGA EN SEGUNDOS: ACRILICO, VINILOS, POLIURETANOS, POLIAMIDAS, POLIESTIRENO, METAL, PORCELANA, CERAMICA, VIDRIO, CAUCHO, CUERO Y CASI TODA CLASE DE MATERIALES POCO POROSOS.

OFERTA DOCENA X 13 UND

DISPARCOL LTDA.

KIT CONECTORES ELECTRICOS

2 VIAS 1/4 COMPLETO (CON-2VH4)

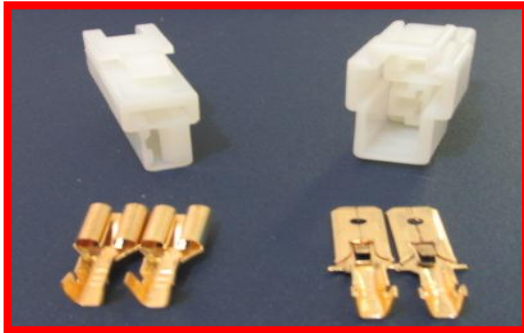

3 VIAS 1/4 COMPLETO (CON-3VH4)

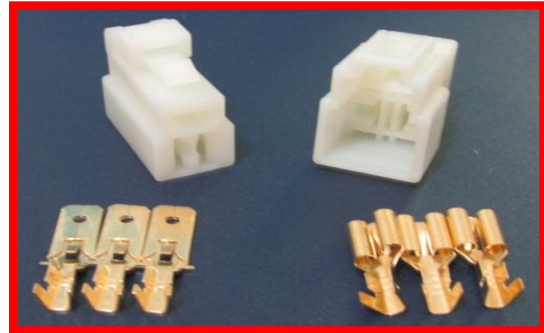

4 VIAS 1/4 COMPLETO (CON-4VH4)

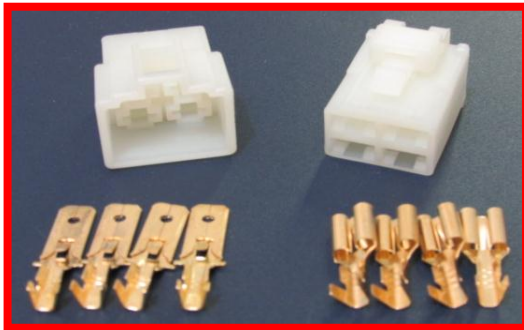

6 VIAS 1/4 COMPLETO (CON-6VH4)

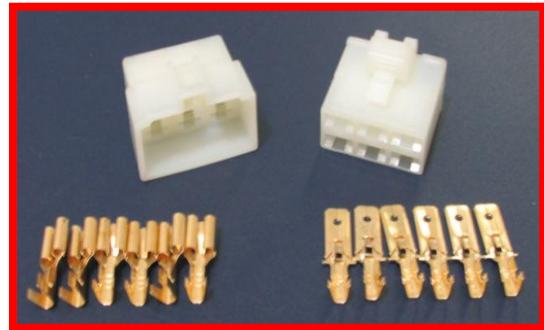

4 VIAS PIN T (CON-4VMP)

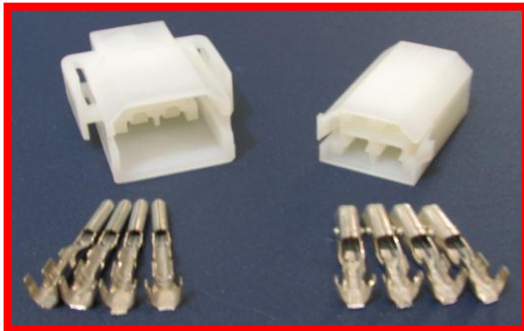

6 VIAS PIN T (CON-6VMP)

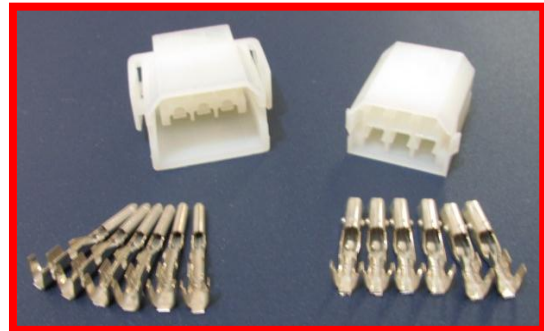

6 VIAS CDI COMPLETO (CON-6VCD)



8 VIAS CDI COMPLETO (CON-8VCD)



SILICONAS



EXCELENTE CALIDAD AL MEJOR PRECIO DEL MERCADO

TRANSPARENTE X 50ML



GRIS X 50ML



NEGRA X 69ML



OFERTA DE INTRODUCCION

POR LA COMPRA DE 1 CAJA X 30 UND DE SILICONA GREY SINTECO GRATIS 6 UND DE SILICONA TRANSPARENTE UNIFIX.

POR LA COMPRA DE 1 CAJA X 30 UND DE SILICONA TRANSPARENTE SINTECO GRATIS 6 UND DE SILICONA NEGRA UNIFIX.

PRECIO ESPECIAL A PARTIR DE 10 UND

LOCTITE® SILICONAS

LA ORIGINAL DE CALIDAD MUNDIAL

TRANSPARENTE X 50 ML



ROJA X 50ML



GRIS X 50ML



LOCTITE - PRECIO DE OFERTA POR LA COMPRA DE 12 UNIDADES - LOCTITE

DISPARCOL LTDA.

VARIOS

TROMPO STOP UNIVERSAL



ADAPTADOR LEVANTA AMORTIGUADOR

AZUL-ROJO-CROMADO-NEGRO



UNION DE CADENA

420

420H

428H

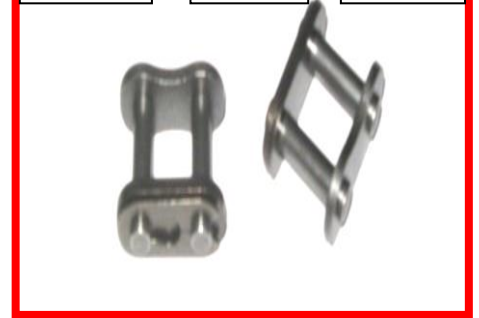

ARANDELAS PIÑON DE SALIDA

XL125-AKT125TT

C70-ECO-BEST125



BOXER 100

PULSAR

TAPAVALVULA TIPO BALA



AZUL-CROMADO-ROJO-NEGRO

TAPAVALVULA TIPO GRANADA



PITO UNIVERSAL 12V



ALETA DE FAROLA NEGRA AX100



ESPEJOS PARA MOTOCICLETAS



ESPEJO IMPORTADO TIPO ITALIANO



ESPEJO IMPORTADO TAPA COLOR BRAZO METALICO AZUL-ROJO-PLATEADO-DORADO



ESPEJO AKT125/EVO/SL



LEVAS DE FRENO TRASERA

LEVA FRENO CROMADA AX/ECO/AKT



LEVA FRENO BOXER100/CT



LEVA FRENO CROMADA GN125/TS125



MANGUERA MOTRIZ



MANGUERA PARA BATERIA 3/16



1/8 BOMBA DE ACEITE



5/32 CARBURADOR



3/16 FILTRO GASOLINA



DISPARCOL LTDA.

FILTROS

FILTROS DE GASOLINA



FILTROS DE ACEITE

**LLAVE GASOLINA AX-
GN-YBR-LIBERO-FZ16**



GN-VIVA-VIVAX-TVS125



SUZUKI DR200



CRYPTON-XTZ 250



**BOXER-DISCOVER-
PULSAR135-XCD- FZ16**



DR350/650-FREWIND650



PULSAR 200 NS



FILTRO AIRE BWS125 4T



EISA

EQUIPOS CARGADORES Y PROBADORES

12 MESES DE GARANTIA

CARGADOR DE BATERIAS MOTO



CARGA DE 1 A 8 BATERIAS DE 6 VOLTIOS Y/O 1 A 6 BATERIAS DE 12 VOLTIOS.

CARGADOR DE BATERIAS MOTO/CARRO



OPCION MOTO: CARGA DE 1 A 8 BATERIAS DE 6 VOLTIOS Y/O 1 A 6 BATERIAS DE 12 VOLTIOS.
OPCION CARRO: CARGA 1 BATERIA DE CARRO O CARGA DE FORMA RAPIDA BATERIAS DE MOTO.

PROBADOR DE CDI-PDI-BOBINAS DE ALTA



CARGADOR Y PROBADOR DE BATERIAS MOTO



ESTE EQUIPO ES LA COMBINACION DE 2 EQUIPOS EN UNO SOLO.

DISPARCOL LTDA.

MANUBRIOS

MANUBRIOS EN ALUMINIO 3 PIEZAS



ORGANIZADORES MODULARES

MODULAR N°3 ALT:8.5CM – ANC:11.5CM – LAR:20CM

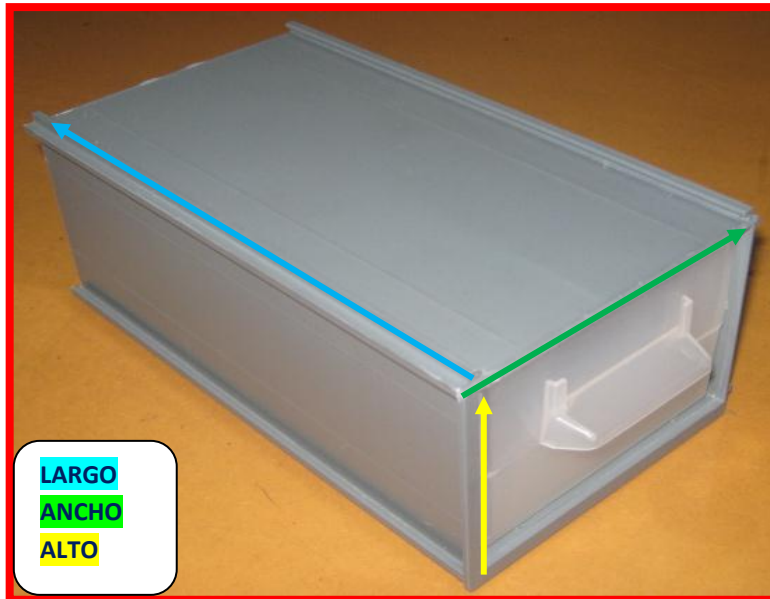

DISPARCOL LTDA.

KIT CONECTORES ELÉCTRICOS

2 VIAS 1/8 COMPLETO (CON-2VH)

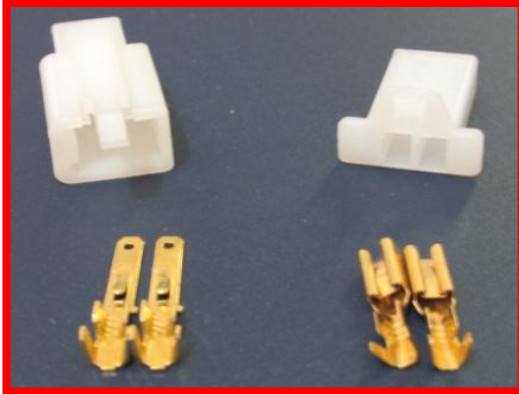

3 VIAS 1/8 COMPLETO (CON-3VH)

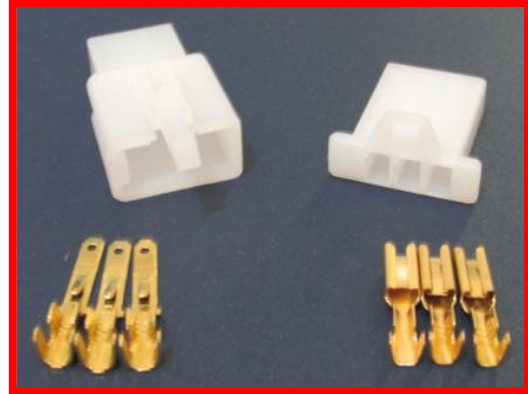

4 VIAS 1/8 COMPLETO (CON-4VH)

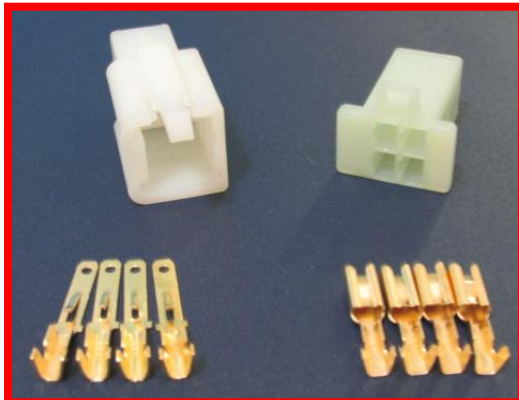

6 VIAS 1/8 COMPLETO (CON-6VH)

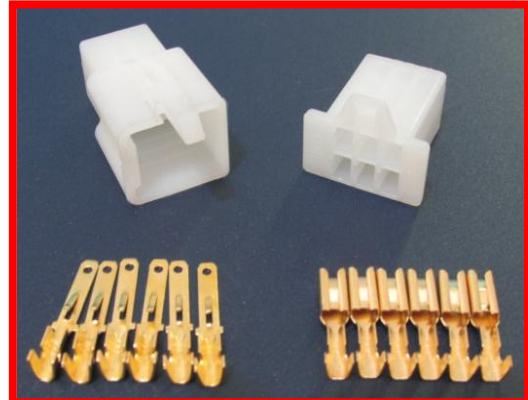

9 VIAS 1/8 COMPLETO (CON-9VH)

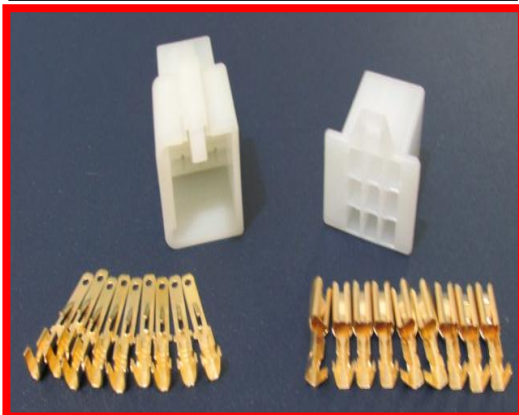

6 VIAS COMPLETO VOLANTE
PULSAR/ DISCOVER (CON-6VPS)

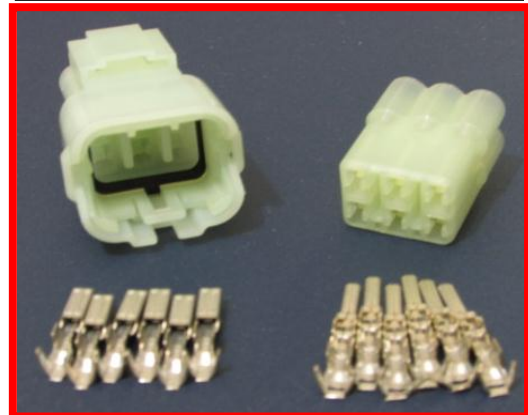

ESTANTE ORGANIZADOR METALICO



ALTURA: 1.50 MT

FONDO: 0.26 MT

ANCHO: 0.96 MT

126 CAJONCILLOS DE 12 X 9 X 6 CMS

DISPARCOL LTDA.

CAUCHOS PARA MOTOCICLETAS

CAUCHOS MANZANA CLUTCH

DT - RX - V-80



ECO100 - CD100



TS - AX - FR



SOPORTE SILLIN

AX100/AKT100

TOPE GATO UNIV



XL 125



AKT125 TT



CUADRADO UNIV



REDONDO UNIV



RX/V-80



AKT 125TT - TRASERO



NUEVO



CAUCHO BUJE AMORTIGUADOR UNIVERSAL

CAUCHOS PARA MOTOCICLETAS

CONECTOR FILTRO AIRE/CARBURADOR

SUZUKI ER100/TS



SUZUKI ER/TS185



SUZUKI FR80/FR100



ZUSUKI TSZ125



YAMAHA DTK125/175



YAMAHA V80



SUZUKI AX100/115-AKT100



AUTECO BAJAJ PULSAR180 DTSI



CAUCHOS PARA MOTOCICLETAS

CAUCHOS DE CAMPANA EN LLANTA (ANTIVIBRANTES)

AX/FR/VIVAX/BEST/AKT100



BOXER100/CT/PLATINO



GN125/GS/AK125EVO M.V



PULSARII/135/200/220-
DISCOVER/CBZ160



LIBERO110/125-YBR125



RX/CRYPTON-STORM125



HONDA CBF150



C70/C90/AKT110/CD100/
ECO100/AKT125W FLEX



HONDA CBF 125



AKT 125-150 EVO M.N



AX 100 4 TIEMPOS



CAUCHOS PARA MOTOCICLETAS

ACOPLE TANQUE GASOLINA

SUZUKI



YAMAHA RX



CAUCHOS PALANCA DE CAMBIOS

FR/TSZ/GP/GN/AX/JINCHENG



XL TODAS/AKT125 TT



YAMAHA TODAS



CAUCHOS BANDAS BATERIA

170 MM -GN125

120 MM

PULSAR

DISPARCOL LTDA.

CAUCHOS PARA MOTOCICLETAS

CAUCHOS PATADA CRANK

V-80/RX/DTK



PULSAR/DISCOVER/BOXER/CBF150



XL TODAS



CAUCHOS TAPA LATERAL

RX/DT



AX/KAW/AKT100



CAUCHOS REPOSAPIE DELANTEROS

FR80/FR100



LIBERO MOD.NUEVO



AX MV/GP/GN/JINCHENG



NUEVO XL125 – AKT125TT

CAUCHOS PARA MOTOCICLETAS

CAUCHOS REPOSAPIES DELANTEROS

RX/V-80/CHAPPY



AX MOD.NUEVO/VIVAX



YBR/CRIPTON/UNIV



AUTECO BOXER



AUTECO PULSAR



HONDA CD100/ECO/SPLENDOR



NUEVOS PRODUCTOS



KIT CAUCHOS CARETA AUTECO-
HONDA (JUEGO X 4)



PULPO EN CAUCHO PLANO X 1MT
(ANTIDERRAPE -EXTIENDE HASTA 3MT)

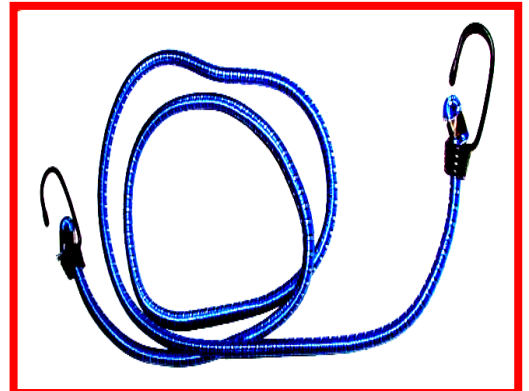

PULPO FINO COLOR AZUL
10MMX 160MM

CAUCHOS PARA MOTOCICLETAS

JUEGOS/KIT ORINGS MOTOS

KIT C70/C90/CD100/ECO



KIT AKT110/JC110/CITY



JUEGO PLATO BOBINA C70/C90/CD100



HERRAMIENTAS

PINZA PARA ANILLOS DE RETENCION



HOMBRESOLO PUNTALARGA

WISE-GRIP 6"

TRUPER 9"

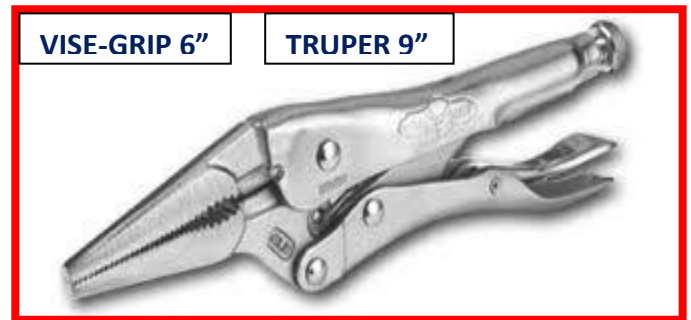

HOMBRESOLO VISE-GRIP 10R



DISPARCOL LTDA.

HERRAMIENTAS

CALIBRADOR DIGITAL 6"



CALIBRADOR ESTÁNDAR



CALIBRADOR DE AIRE



LLAVES BRISTOL MILIMÉTRICAS

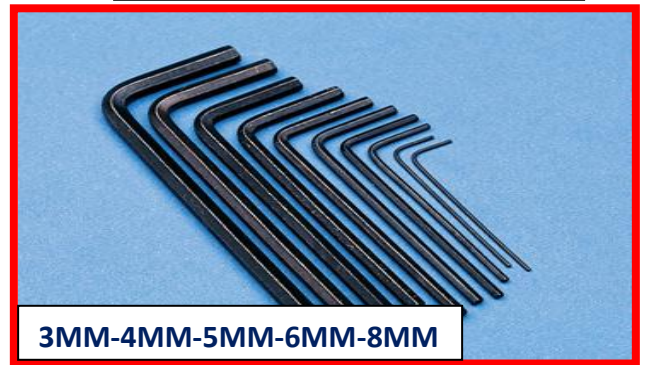

3MM-4MM-5MM-6MM-8MM

ATORNILLADOR DE IMPACTO



MACHUELOS PARA ROSCAR



3MM A 14MM - 3/8 A 1/2

Finishing

HERRAMIENTAS

DADOS DE TARRAJA MILIMETRICOS



6MM-8MM-10MM-12MM-14MM

VOLVEDOR PARA MACHUELOS



PEQUEÑO - GRANDE

VOLVEDOR PARA DADOS DE TARRAJA



1" - 1 1/2 "

LLAVES EN T

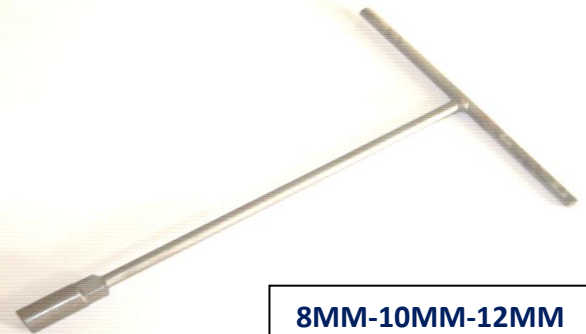

8MM-10MM-12MM

BOMBA INFLANTAS DE PEDAL

Bomba de pedal
1 pistón

PRETUL

VAL-BA: precio por bolsa con 100 piezas

VAL-BA

BOPE-P

PUNTAS PARA IMPACTO IMANTADAS

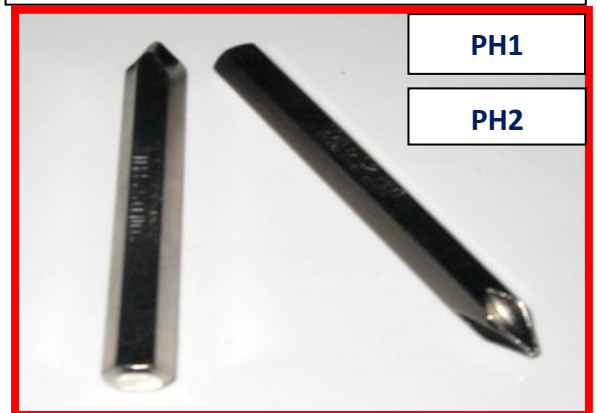

HERRAMIENTA ESPECIALIZADA

MOTOS

CORTACADENA UNIV



REPUESTO CORTACADENA



CORTACADENILLA UNIV

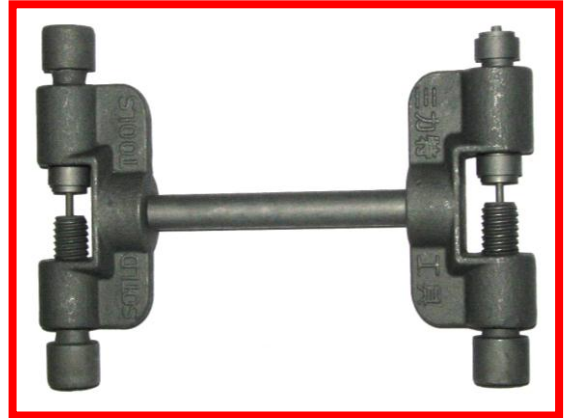

LLAVES DE BUJIA



10MM-12MM-14MM

EXTRACTOR UÑAS VALVULAS



LLAVE TUERCA CIGUEÑAL/PRENSA
ECO100-CD100-SPLENDOR-AKT125 S



LLAVE TUERCA CIGÜEÑAL/PRENSA
AUTECO BOXER-DISCOVER



DISPARCOL LTDA.

HERRAMIENTA ESPECIALIZADA

MOTOS

EXTRACTOR VOLANTA ECO DE LUXE
YBR125/GN125/GS125



EXTRACTOR VOLANTA AKT125/ECO100



EXTRACTOR VOLANTA DTK/MOTOS 2T
/ECO100 M.V / BOXER100



EXTRACTOR PIÑÓN PRIMARIO XL – AKT125



EXTRACTOR VOLANTA PULSAR -DISCOVER



EXTRACTOR BULON DE PISTON



SUZUKI AX100/115



HONDA CBF 150



AKT110-VIVA115-BEST125



EMPAQUETADURA PARA MOTOS



ALTA CALIDAD Y BUEN CASE



EMPAQUETADURA PARA KIT COMPLETO – KIT MEDIO - TAPA CLUTH – CULATAS – CILINDROS – CENTRO MOTOR – VOLANTES – EXHOSTOS – COMPLEMENTO EXHOSTOS – CONECTORES – TAZA CARBURADOR – BASE CARBURADOR – TORQUES – TRANSMISION – TAPA BOMBA DE ACEITE – BOMBA DE ACEITE –ADAPTACIONES.

DISPARCOL LTDA.

PRODUCTOS UNIFIX



PRODUCTO LIQUIDO DE 2 COMPONENTES ESPECIALMENTE DISEÑADO PARA REPARACIONES EN METALES. SIRVE PARA REPARAR PARTES DE MOTORES, REHACER PIEZAS, SELLAR Y MUCHAS APLICACIONES MAS. **OFERTA X 6 UND – GRATIS 1**

PEGA: ACERO, ALUMINIO, BRONCE, COBRE, LATON.

PRODUCTOS MOTOKER



LUBRICANTE DE CADENAS

150ML

PROLONGA LA VIDA UTIL DE LA CADENA. REDUCE LA FRICCION Y EL DESGASTE, PROTEGE CONTRA LA CORROSION Y REPELE LA HUMEDAD.

OFERTA X 6 UND – GRATIS 1

DISPARCOL LTDA.

ORGANIZADORES PLASTICOS

ESTUCHE PLASTICO 18 COMPARTIMIENTOS

ANCHO: 36CM LARGO: 28CM ALTURA: 0.6CM



ESTUCHE PLASTICO 15 COMPARTIMIENTOS (PEQUEÑO)

ANCHO: 28CM LARGO: 17CM ALTURA: 0.4 CM



DISPARCOL LTDA.

FILTROS DE AIRE

YAMAHA BWS 125 4T



YAMAHA XT 660



YAMAHA FZ 16



HONDA CBF 125



HONDA CBF 150



HONDA STORM 125



AKT DINAMIC 125/AKT JET 150
(SCOOTER CHINAS)



KYMCO AGILITY 125/150



PRODUCTOS DE CALIDAD
ORIGINAL – GARANTIA TOTAL

DISPARCOL LTDA.

CAUCHOS PARA MOTOCICLETAS

CAUCHOS DE CAMPANA

(LINEA ECONOMICA)

AX-BEST-FR-VIVA-VIVAX



RX-CRYPTON-STORM125



GN125-GS125-UM220



C70-C90-ECO-SPLENDOR-
CD100-AKT110-125FLEX



PULSARII-PULSAR135-200-
220-DISCOVER-CBZ160



HONDA XL100-125



BOXER100-CT-PLATINO



DISPARCOL LTDA.

PRODUCTOS



DESPINCHADOR INSTANTANEO DE LLANTAS

NUEVO

.INFLA Y SELLA INSTANTANEAMENTE
LLANTAS CON O SIN NEUMATICO.

.NO DAÑA LA LLANTA, EL NEUMATICO
NI EL RIN.

PARA AUTOS, MOTOCICLETAS Y
BICICLETAS.

.NO REQUIERE DESMONTAR LA
LLANTA NI EL NEUMATICO.



MADE IN
U.S.A

LUBRICANTE EN AEROSOL WT-400

NUEVO

PRESENTACION ESPECIAL PARA
MOTOCICLISTAS 110ML

AFLOJA PIEZAS OXIDADAS Y CORROIDAS.



PENETRA, LUBRICA Y LIBERA RESORTES,
BISAGRAS, CANDADOS, RUEDAS Y PARTES
MOVILES. ELIMINA LA HUMEDAD DE
EQUIPOS ELECTRICOS.

DISPARCOL LTDA.



ACEITERA METALICA 180CC

> Boquilla de latón sólido
> Aplicador flexible

ACEF-500

RATCHE PROFESIONAL TRABAJO LIVIANO

1/2"

PISTOLA NEUMATICA 1/2

MECANISMO ROCKING DOG

Esta pistola sustituye a la TPN-731E ofreciendo un mejor desempeño

ESPECIFICACIONES	
Capacidad del cuadro:	1/2"
Velocidad sin carga:	6.500 rpm
Consumo nominal:	4CFM@90PSI
Máximo torque:	280 lb/ft
Conexión de entrada de aire:	1/4 NPT
Diámetro interno de manguera:	3/8"
Desalzo de aire:	Inferior

2 años Garantía

PULIDOR DE CILINDROS DE MOTOR (BRUÑIDOR)

Apertura máxima: 7"

REP-RECI-3

RATCHE TIPO PERA INDUSTRIAL. TRABAJO PESADO

Excede en promedio un 80% la norma en torque ASME B107.10

REP-M5449

M-5449

1/2"

ADAPTADOR PARA RATCHE 1/2 A 3/8

Excede en promedio un 20% la norma en torque ASME B107.10

1/2"

CAJA DE HERRAMIENTAS PLASTICA 16" O 19"

CHA-19G

CHA-22G

DESTORNILLADOR DE 4 PUNTAS INTERCAMBIABLES

Poligonales

- 3/16" x 4"
- #1 y 2#
- 3/16" y 1/4"

Excede las normas. Especific. ASME B107.600



PINZA DE PUNTA LARGA 6" O 7"

que las de acero al carbono

- > Mango de vinil de alto desempeño
- > Recubrimiento satinado, 3 veces más resistente a la corrosión

Exceden la norma: Especificación ANSI B107.13M

PINZA CORTE DIAGONAL 7"

vanadio, 2 veces más resistente que las de acero al carbono

- > Mango de vinil de alto desempeño
- > Recubrimiento satinado, 3 veces más resistente a la corrosión

Exceden la norma: Especificación ANSI B107.11M

ALICATE TIPO ELECTRICISTA 8"

vanadio, 2 veces más resistente que las de acero al carbono

- > Mango de vinil de alto desempeño
- > Recubrimiento satinado, 3 veces más resistente a la corrosión

Exceden la norma: Especificación ANSI B107.20M

JUEGO DE HERRAMIENTAS 5 PIEZAS

1 Pinzas de chofler 6"
1 Pinzas de punta y corte 6"
1 Llave ajustable 8"
1 Pinzas de electricista 8"

Exceden la norma: Especificación ANSI B107.13M

JUEGO DE LLAVES MIXTAS MM 9 PZAS

MEDIDAS	
J-129P	J-129M
3/16"	6 mm
7/16"	9 mm
1/2"	10 mm
9/16"	11 mm
5/8"	12 mm
11/16"	13 mm
3/4"	14 mm
13/16"	15 mm
7/8"	17 mm

Norma: ASME B107.6 / Norma: ASME B107.100

LLAVES MIXTAS MILIMETRICAS

Acabado Pulido espejo

Exceden en promedio un 80% la norma en torque ASME B107.100

HOMBRESOLO DE CADENA 8"

Entrada para llave allen

MALETIN DEPORTIVO 2013

Base: 49 cm
Altura: 35 cm
Fondo: 33 cm

Recargable, 20 lúmenes 5 leds

> Cuerpo de ABS de gran resistencia al impacto

Se conecta directamente a la corriente eléctrica

ESPECIFICACIONES			
Lúmenes	Vida del foco	Duración de carga	Máx. distancia de iluminación
20 lm	100,000 h	10 h	45 m

LINTERNA



JUEGO DE 13 LLAVES BRISTOL MM ESTUCHE PLASTICO

PRETUL

MEDIDAS	
ALL-13P-P	ALL-13M-P
3/16"	1.3 mm
1/16"	1.5 mm
5/64"	2 mm
3/32"	2.5 mm
7/64"	3 mm
1/8"	3.5 mm
5/64"	4 mm
5/32"	4.5 mm
3/16"	5 mm
7/32"	5.5 mm
1/4"	6 mm
5/16"	8 mm
3/8"	10 mm

Cumplen con la norma: ANSI B18.3.2 M

JUEGO DE 8 LLAVES BRISTOL MM TIPO LLAVERO

PRETUL

MEDIDAS	
ALL-P8P	ALL-P8M
1/16"	1.5 mm
5/64"	2 mm
3/32"	2.5 mm
1/8"	3 mm
5/32"	4 mm
3/16"	5 mm
7/32"	5.5 mm
1/4"	6 mm

JUEGO DE 7 LLAVES BRISTOL MM TIPO NAVAJA

TRUPER

MEDIDAS	
ALL-7P	ALL-7M
1/16"	1.5 mm
5/64"	2 mm
3/32"	2.5 mm
1/8"	3 mm
5/32"	4 mm
3/16"	5 mm
7/32"	6 mm

Exceden en promedio un 30% la norma en torque ANSI: B18.3.2 M

PONCHO PLASTICO AMARILO - DELGADO

PRETUL

Prensas hidráulicas con manómetro, 12 Y 20 toneladas

TRUPER

- PISTON CON RETORNO AUTOMATICO.
- MANOMETRO PARA MEDIR LA PRESION APLICADA.
- MESA AJUSTABLE.
- GATO HIDRAULICO FACIL DE USAR.
- IDEAL PARA TRABAJOS DE ENDEREZADO, DOBLADO Y TROQUELADO.

TORQUIMETRO

TRUPER

- > Fabricado en acero cromo vanadio
- > Rango de torque: 20 - 150 lb/ft (27.2 - 204 Nm)
- > Incremento dual: 1 lb/ft
- > 24 Dientes por matraca

1/2"
Norma: ASME B107.14

ENVIO GRATIS A NIVEL NACIONAL.
EXCEPTO SAN ANDRES ISLAS Y LETICIA.



COMPRESOR LUBRICADO 60Lt – 3HP

- > 2 Solenos de alta presión máxima y presión regulable
- > 2 Manómetros con presostato
- > Arranque automático y manual
- > Interruptor termomagnético
- > Incluye aceite multigrado SAE30

ESPECIFICACIONES

Potencia:	2,200 W / 3 HP
Tensión:	120 V / 60 Hz
Velocidad:	3,400 rpm
Presión Mx:	127.6 PSI - 8.8 Bar
Tipo:	Monofásico
Motor:	Lubricado
Flujo continuo:	250 L / min
FLUJO DE AIRE	
	8.5 CFM @ 40 PSI
	7.5 CFM @ 90 PSI

PRENSA DE BANCO INDUSTRIAL 5"

- > Fundidos en hierro gris de alta resistencia para trabajo pesado
- > Base giratoria
- > Mordazas de acero intercambiables y moleteadas para un mejor agarre

TA-6

Exceden la norma: Especific. Federal: GGG-V-415

MULTIMETRO DIGITAL (TESTER)

- > Función de diodo y transistor
- > Batería incluida (9 V)

ESPECIFICACIONES

Funciones	Rango
Voltaje CC	200 mV - 1,000 V
Voltaje CA	200 V - 750 V
Corriente CC	200 µA - 10 A
Resistencia	200 Ω - 2,000 K Ω

JUEGO DE PUNTAS Y GANCHOS PARA EXTRAER RETENEDORES

Punzón recto
 Ángulo a 45°
 Ángulo a 90°
 Gancho completo

EXTRACTOR DE RODAMIENTOS CIGÜEÑAL

2 1/4 Y 4 1/4

LLAVE EXTRACTORA 10 PCZ (PARA UTILIZAR CON EL EXTRACTOR DE RODAMIENTOS CIGÜEÑAL)

Alcance máximo: 32 mm
 Cabeza de tornillo: 5/8"

CAUCHOS PARA MOTOCICLETAS

CAUCHOS DE CAMPANA TIPO ORIGINAL
LLANTALONA (ANTIVIBRANTES)

CALIDAD SUPERIOR AL ORIGINAL

AX/FR/VIVA/BEST/AKT100



RX/V-80/CRIPTON



GN125/GS125/GP125



C70/C90/CD100/ECO100/SPLENDOR



BOXER/NEOMAX



PULSAR/DISCOVER



DISPARCOL LTDA.

DIRECCIONALES FLEXIBLES 12V

MINI AX100/115 TRANSPARENTE



MINI AX100/115 NARANJA



MEDIANA AX100/115 TRANSPARENTE

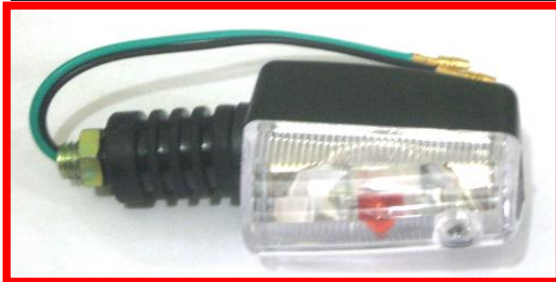

MEDIANA AX100/115 NARANJA



BOXER100 CT MOD.NUEVO TRANSPARENTE DER/IZQ.



CAPUCHON DE BUJIA UNIVERSAL



DISPARCOL LTDA.

HERRAMIENTA ESPECIALIZADA MOTOS

EXTRACTOR VOLANTE UNIVERSAL – MOTOS CHINAS



LLAVE SUJETA VOLANTA REDONDA



VARILLA FLEXIBLE CON IMAN



KIT EXTRACTOR BALINERAS MOTO

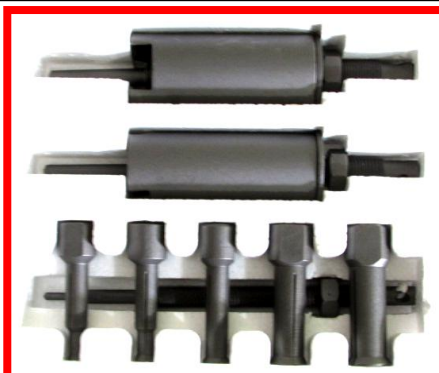

LLAVE SUJETA VOLANTA TIPO TENAZA



KIT EXTRACTOR BALINERAS Y CARCAZAS TIPO GUILLOTINA



RAMPLA HIDRAULICA - CAPACIDAD 800 LB



DISPARCOL LTDA.

RANGER®

QUALITY TOOLS

BISTURI PROFESIONAL (INTERIOR METALICO)



JUEGO DE LLAVES MIXTAS MILIMETRICAS - 14 PCS



ENGRAPADORA NEUMATICA

GRATIS CAJA X 5000 GRAPAS

- Ideal para tapicería y trabajos de muebles.
- Excelente para marcos de fotos, hobby y aplicaciones decorativas.
- Usa grapas serie 80 (corona de 12.80 mm)
- Rango de las grapas 6mm a 16mm (1/4" a 5/8").
- Consumo de aire 1.2cfm.
- Presión de aire recomendada: 90 psi
- Ideal para compresores pequeños.



RANGER®
QUALITY TOOLS

MODEL 8015
7000 GRAPAS (SERIE 80A-100A)

JUEGO DE COPAS MILIMETRICAS – 29 PCS – CUADRANTE 1/2



CARRITO DE SERVICIO TALLER (3 NIVELES)
ESPECIFICACIONES: 71 X 36 X 8.5 ALT.MAX: 80
CAP.DE CARGA: 120 KG



RANGER®

QUALITY TOOLS

DESTORNILLADORES PROFESIONALES – MANGO RESISTENTE A GOLPES Y COMBUSTIBLES

1/8 X 8 ESTRIA



1/8 X 8 PALA



1/4 X 4 PALA



1/4 X 4 ESTRIA



JUEGO DESTORNILLADORES X 4 PCS



JUEGO DESTORNILLADORES X 10 PCS



DISPARCOL LTDA.

ORGANIZADORES MODULARES

POLIPROPILENO DE ALTO IMPACTO – COLOR GRIS

MODULAR N°4 ALT:15CM – ANC:17CM – LAR:25CM

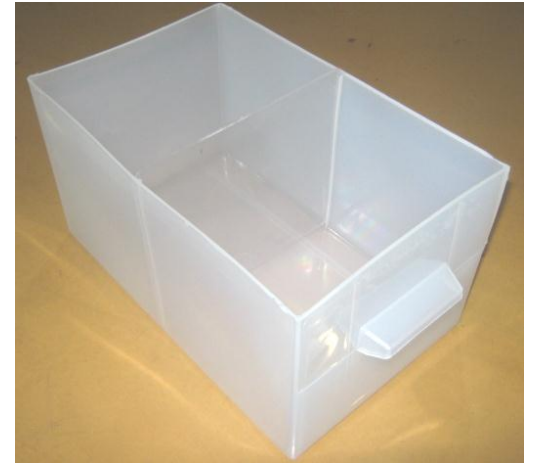
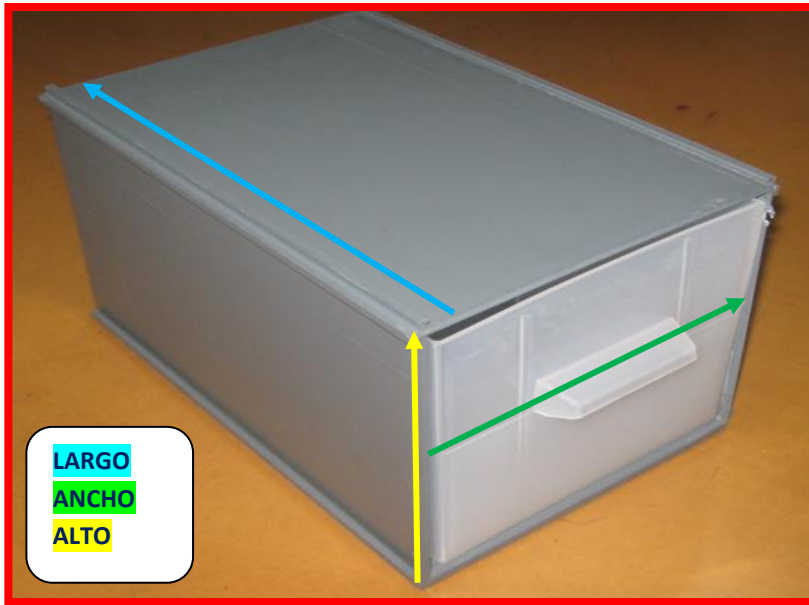

MODULAR N°5 ALT:12CM – ANC:15CM – LAR:30CM

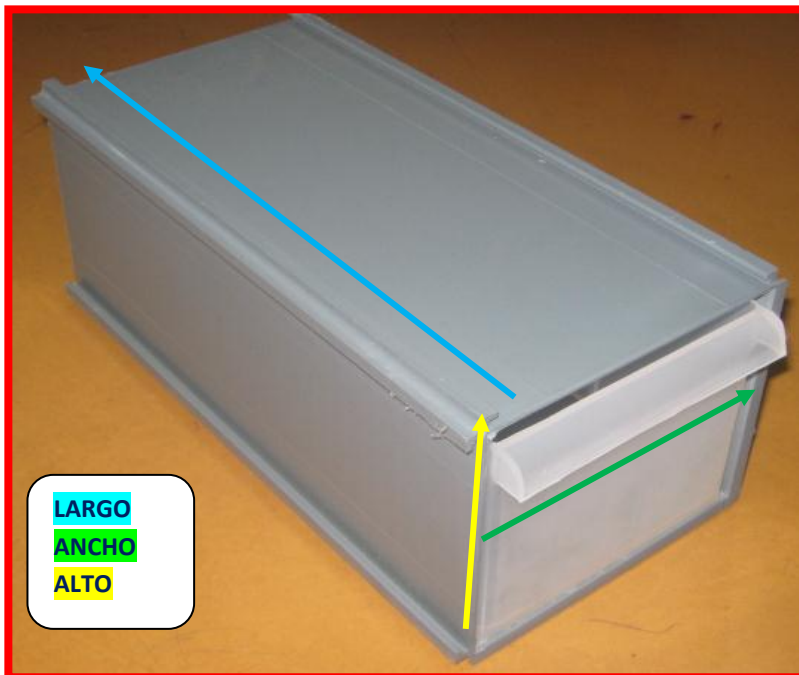

DISPARCOL LTDA.

ELECTRICOS

RAMAL VOLANTE DTK MOD.VIEJO

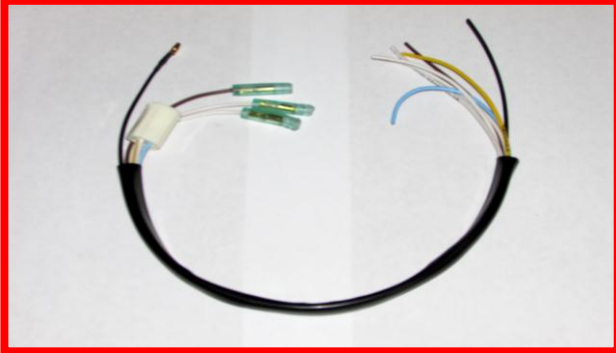

BALASTRO PARA STOP PULSAR INTERMITENTE



PORTAFUSIBLE DOBLE TRANSPARENTE

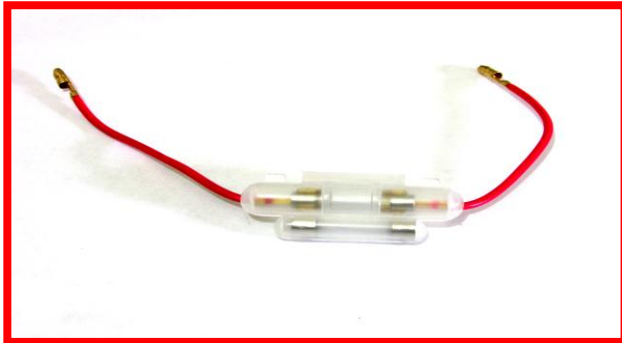

PORTAFUSIBLE MODELO NUEVO TIPO AUTOMOTRIZ

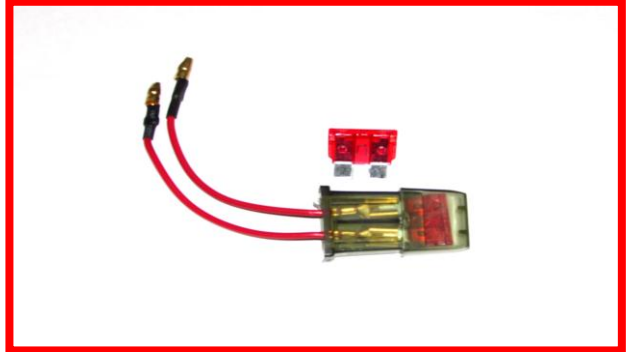

CHEQUEADOR DE LUCES 6-12 VOLTIOS

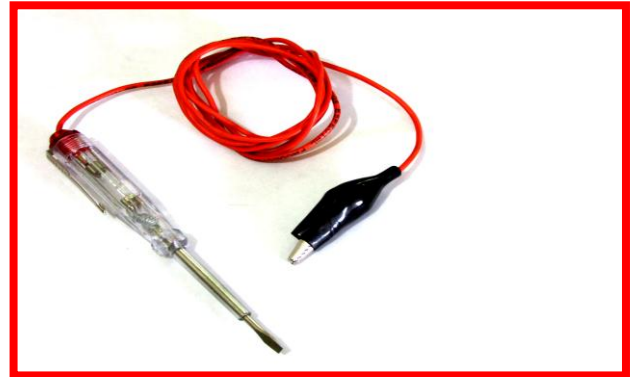

FUSIBLES DE REPUESTO

TUBULAR 10A -15A -20A -25A -30A CAJA X 100



**CONECTOR DE FLASHER
2 VIAS.**



SOCKET DE FAROLA

PULSAR/DTK/BOXER



AX100 MOD.NUEVO



RX 115



1 PATA – V80/CRYPTON/C90



CARRETEL DE ACELERADOR

AX100/115 CAÑA



DTK100/125/175



RX100/115-LIBERO100



BOXER



PULSAR



ECO/SPLENDOR



HERRAMIENTA ESPECIALIZADA MOTOS

EXTRACTOR VELOCIMETRO
AKT125/SIGMA125



EXTRACTOR TIJERA AKT125/SIGMA125



EXTRACTOR GUIA
VALVULAS



LLAVE PARA AJUSTAR TORNILLOS BALANCIN

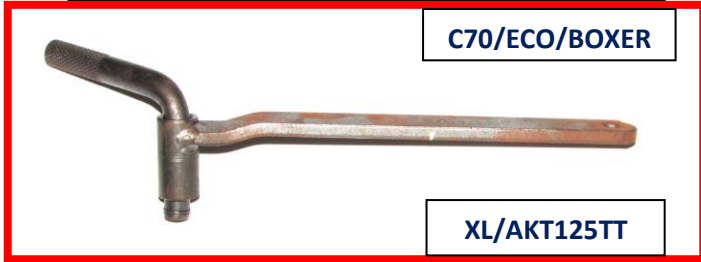

C70/ECO/BOXER

XL/AKT125TT

SOSTENEDOR DE CORONA
CLUTH BOXER



EXTRACTOR DE TRES PATAS
(VOLANTES O PIÑONES)



KIT REPARACION LLANTA SELLOMATIC



HTM-KRHS

KIT DESPINCHE LLANTA SELLOMATIC



HTM-KDLS

DISPARCOL LTDA.

PATAS LATERALES

AX100/115



GS 125



DR 200



VIVA/VIVAX



GN 125



YAMAHA V-80



YAMAHA DTK125/175



AUTECO BOXER



AKT 110



PRODUCTOS NQK-SHANFENG

FABRICADOS EN INDIA BAJO ESTANDARES DE CALIDAD JAPONESES

KIT PIÑONES DE LUBRICACION C90/ECO100



CANASTILLA EJE CLUTH BOXER100/CT



RETENEDORES (DOBLE RESORTE)



SELLOS DE VALVULA HONDA C70



SELLOS DE VALVULA AUTECO BOXER/PLATINO



SELLOS DE VALVULA C90/CD100/ECO-AKT110



DISPARCOL LTDA.

CONECTORES ELECTRICOS (PACHAS)

CONECTOR 2-3 VIAS 1/4 HEMBRA

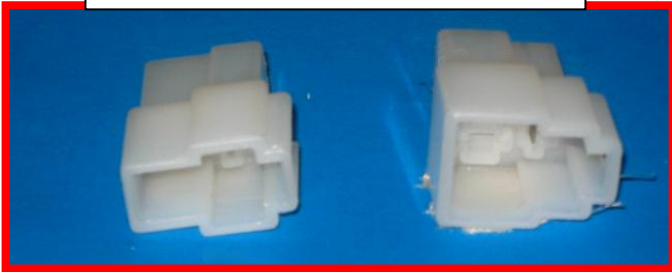

CONECTOR 4-6 VIAS 1/4 HEMBRA



CONECTOR 4-6 VIAS MACHO PIN T

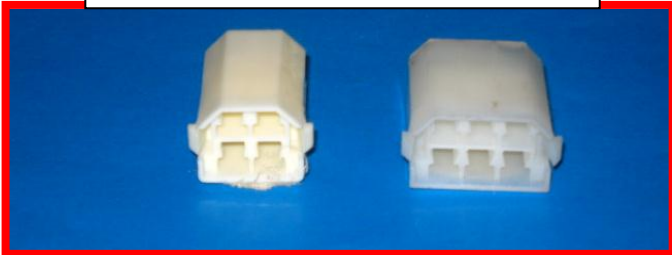

CONECTOR 4-6 VIAS HEMBRA PIN T

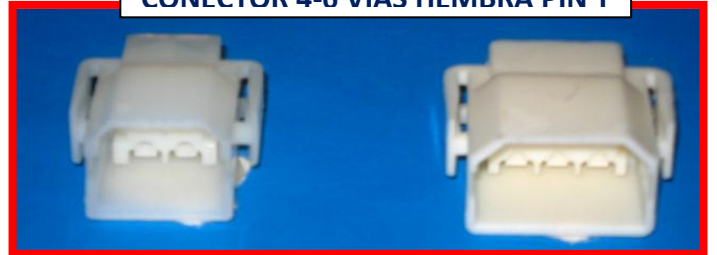

**TERMINALITO COHETE
HEMBRA -MACHO**



**TERMINALITO CDI
HEMBRA - MACHO**



CONECTOR 3 VIAS FAROLA



HERRAMIENTAS ELÉCTRICAS



TALADRO PERCUTOR DE 3/8 – 500W
VELOCIDAD VARIABLE Y REVERSIBLE
2800RPM



TALADRO DE ARBOL DE 1/2 – 600W
2 1/3 HP – 5500RPM – ALTURA 60CMT



ESMERIL DE BANCO DE 6" – 370W – 1/2HP
3450RPM – EJE DE 1/2"



MOTO TOOL - 240W – 3 VELOCIDADES
8000 A 30000 RPM

CAUCHOS PARA MOTOCICLETAS

REPOSAPIES TRASEROS



PATAS LATERALES

SUZUKI BEST 125



YAMAHA LIBERO 110



KIMCO AGILITY MOD.NUEVO



YAMAHA BWS 100



YAMAHA
CRYPTON



YAMAHA FZ16



HONDA
CD100/SPLENDOR



AKT 125

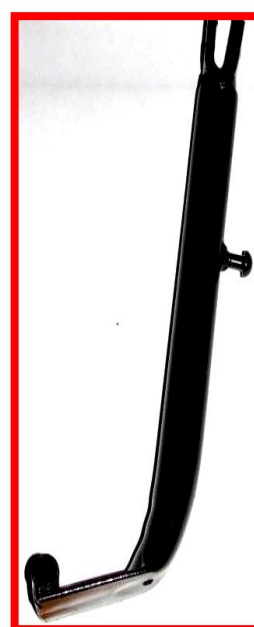

KIMCO AGILITY
MOD.VIEJO



NUEVOS RESORTES

**RESORTE PEDAL DE FRENO SUZUKI AX100
4 TIEMPOS (RPF-14.010)**



**RESORTE
TELESCOPICOS
HONDA NXR/BROSS
(RBT-05.003)**

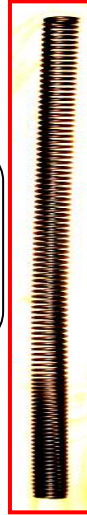

**RESORTE PEDAL DE FRENO PULSAR
180UG-200-220 (RPF-02.007)**



**RESORTE DE CRANK
SIGMA 125/150 SPORT
(RDC-13.002)**



**RESORTE PIN DE CRANK YAMAHA
BWS100 (RPC-16.002)**

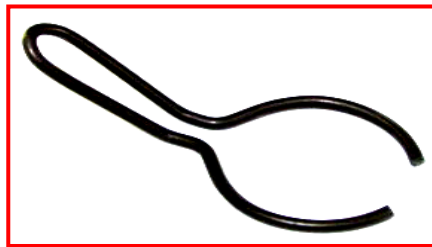

**RESORTE BANDAS FRENO YAMAHA
FZ16 (JUEGO X 2) RBF-16.004**



**RESORTE DE CRANK
YAMAHA FZ16
(RDC-16.010)**



MOTOS

**RESORTE LEVA DE CLUTH YAMAHA
FZ16-LIBERO125-YBR125 (RLC-16.006)**



**RESORTE DE CRANK HONDA CBF 150
(RDC-05.007)**



**RESORTE EJE DE CAMBIOS HONDA
CBF150-CB110 (REC-05.002)**



**RESORTE BANDAS FRENO YAMAHA
BWS 125 (JUEGO X 2) RBF-16.005**



JUEGO BUJES EN TEFLON/METAL PARA TIJERA

DTK 125



PASADORES DE MORDAZA



AKT110-125



SUZUKI TSZ 125



PULSAR



YAMAHA XTZ 250

PASADOR GATO CENTRAL

PASADOR AUTECO BOXER



PASADOR CD100/ECO100- DELUXE



DISPARCOL LTDA.

LLAVE DE GASOLINA

NUEVOS PRODUCTOS

TS125/AX100 M.V



AKT125 SL/SPORT



GN125/AX100-2



BOXER100 CT
PLATINO



PULSAR II



SWITCH DE ENCENDIDO

CD100 / ECO100



DTK 125



BOXER100 CT



RX 115 DE SEGURIDAD



GN125



AX100



V80 MOD NUEVO



DISPARCOL LTDA.

PEDAL DE ENCENDIDO

AKT 125 S/ SL



BOXER CT
PLATINO



CD100/ECO100



VIVA/VIVAX115



DTK 125



AX100/115



V-80



PEDAL DE FRENO

AX 100/115



YBR 125



GN 125



AKT 125 S



ECO 100



BOXER 100 CT



PALANCA DE CAMBIOS

DISCOVER



AKT 125 S



LIBERO



AX 100



YBR 125



CBF 150



DTK 125



GN 125 H



BOXER100 CT



ECO DELUXE



ECO100+



DESLIZADORES DE CADENA (PRODUCTO EN OFERTA HASTA AGOTAR INVENTARIOS)

HONDA ECO-ESPLENDOR (DDC-05.001)



YAMAHA V80 (DDC-16.002)



KIT PIÑÓN SPROKET DEL/TRAS

LIBERO 14TX44T



VIVA115 14TX35T



AKT125 SL 15TX38T



AX100/115 14TX42T



**DTK125 4 HUECOS
15TX47T**



**DISCOVER125
14TX42T**



**ECO DE LUXE
14TX44T**



**CD100/ECO100
14TX44T**



RX100 14TX38T



**PULSAR II 4
HUECOS 14TX42T**



ELABORADOS EN ACERO SAE 1045

PIÑONES CONTRAMARCADOS JAPAN TECHNOLOGY

DISPARCOL LTDA.

KIT PIÑÓN SPROKET DEL/TRAS

AKT125 S 14TX38T



AKT110 S 14TX36T



BOXER CT/PLATINO
14TX42T



BOXER CT/PLATINO
13TX42T



XCD125 15TX42T



CBF150 15TX43T



CBZ160 14TX46T



YBR125 14TX43T



ELABORADOS EN ACERO SAE 1045

PIÑONES CONTRAMARCADOS JAPAN TECHNOLOGY

DISPARCOL LTDA.

BOMBILLOS HALOGENOS

HIR 12 VOLTIOS (I.D.L JAPAN)

TRIZETA RESISTENCIA
EXTERNA 35X35



TRIZETA DOBLE
BOMBILLO 35X35



AX100 M.N RESISTENCIA
EXTERNA 35X35



1 PATA RESISTENCIA
EXTERNA 25X25



1 PATA DOBLE
BOMBILLO 35X35



AX100 M.N DOBLE
BOMBILLO 35X35



DISEÑO NOVEDOSO
CALIDAD GARANTIZADA

DISPARCOL LTDA.

CADENA REFORZADA

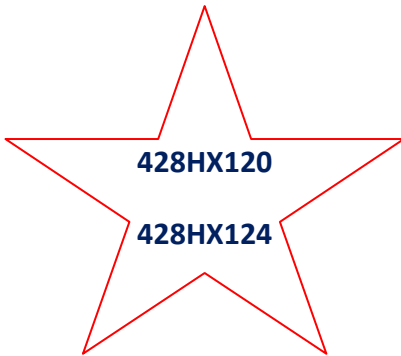

428HX120

428HX124

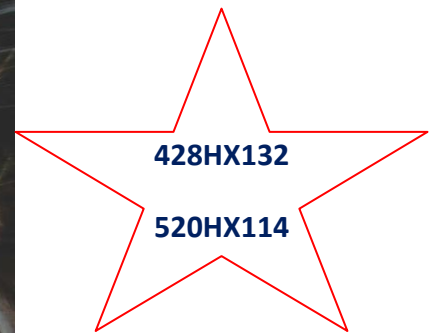

428HX132

520HX114



LA CADENA KETOZ CUENTA CON DOBLE CERTIFICACION INTERNACIONAL LO QUE GARANTIZA SU CALIDAD Y DURABILIDAD.

LA CADENA KETOZ SE EXPORTA A MAS DE 25 PAISES, ESTO ES SINONIMO DE CONFIABILIDAD.

WWW.KETOZ-CHAIN.COM



DISPARCOL LTDA.

NUEVOS PRODUCTOS



CABLES TRENZADOS

CHOKE CAB.FOSFORO



CLUTH CAB.GRANDE



CLUTH CAB.PEQUEÑA



ACELERADOR UNIV.



ESPARRAGOS CILINDRO ECO/SPLENDOR



HERRAMIENTA ESPECIALIZADA MOTOS

LLAVE TEMPLARADIOS

8G/9G

10G/11G



NUEVOS PRODUCTOS

NEWS

REPOSAPIES TRASEROS DE LUJO

TIPO RESORTE CROMADO



TIPO RESORTE NEGRO



VALVULAS PARA LLANTA

TAPAVALVULAS CON LUZ LED INTERMITENTE AZUL (SE ACTIVA CON EL MOVIMIENTO)



VALVULAS EN ALUMINIO ROJA-NEGRO-AZUL



DISPARCOL LTDA.

MEGA PROMOCION ❖❖❖ JULIO-AGOSTO

**POR COMPRAS MAYORES A \$ 1.500.000 (ANTES DE IVA)
LLEVESE ESTE ESPECTACULAR MALETIN
DEPORTIVO.**

ESPECIFICACIONES

Base:	49 cm
Altura:	35 cm
Fondo:	33 cm



PROMOCION VALIDA A NIVEL NACIONAL

DISPARCOL LTDA.

DISPARCOL LTDA.